



■ Features

- Wide input range 180 ~ 528VAC
- Constant Voltage + Constant Current mode output
- Metal housing with Class I design
- Built-in active PFC function
- IP67 / IP65 rating for indoor or outdoor installations
- Function options: output adjustable via potentiometer; 3 in 1 dimming (dim-to-off); Timer dimming
- Typical lifetime > 50000 hours
- 5 years warranty

■ Applications

- LED street lighting
- LED high-bay lighting
- Parking space lighting
- LED fishing lamp
- LED greenhouse lighting

■ Description

HVG-65 series is a 65W AC/DC LED driver featuring the dual mode constant voltage and constant current output. HVG-65 operates from 180~528VAC and offers models with different rated voltage ranging between 12V and 54V. Thanks to the high efficiency up to 90%, with the fanless design, the entire series is able to operate for -40°C ~ +80°C case temperature under free air convection. The design of metal housing and IP67/IP65 ingress protection level allows this series to fit both indoor and outdoor applications. HVG-65 is equipped with various function options, such as dimming methodologies, so as to provide the optimal design flexibility for LED lighting system.

■ Model Encoding

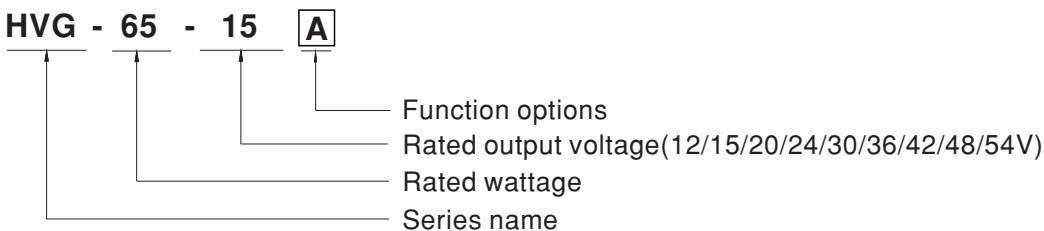

| Type | IP Level | Function | Note |
|------|----------|--|------------|
| A | IP65 | Io and Vo adjustable through built-in potentiometer. | In Stock |
| B | IP67 | 3 in 1 dimming function (0~10Vdc, 10V PWM signal and resistance) | In Stock |
| D | IP67 | Built-in Smart timer dimming function by user request. | By request |



SPECIFICATION

| MODEL | | HVG-65-12 | HVG-65-15 | HVG-65-20 | HVG-65-24 | HVG-65-30 | HVG-65-36 | HVG-65-42 | HVG-65-48 | HVG-65-54 | |
|---------------------|---|---|-------------|--------------|--------------|-------------|--------------|--------------|--------------|--------------|--|
| OUTPUT | DC VOLTAGE | 12V | 15V | 20V | 24V | 30V | 36V | 42V | 48V | 54V | |
| | CONSTANT CURRENT REGION Note.4 | 7.2 ~ 12V | 9 ~ 15V | 12 ~ 20V | 14.4 ~ 24V | 18 ~ 30V | 21.6 ~ 36V | 25.2 ~ 42V | 28.8 ~ 48V | 32.4 ~ 54V | |
| | RATED CURRENT | 5A | 4.3A | 3.25A | 2.71A | 2.17A | 1.81A | 1.55A | 1.36A | 1.21A | |
| | RATED POWER | 60W | 64.5W | 65W | 65W | 65.1W | 65.2W | 65.1W | 65.3W | 65.3W | |
| | RIPPLE & NOISE (max.) Note.2 | 120mVp-p | 150mVp-p | 150mVp-p | 150mVp-p | 200mVp-p | 200mVp-p | 300mVp-p | 300mVp-p | 300mVp-p | |
| | VOLTAGE ADJ. RANGE | Adjustable for A-Type only (via the built-in potentiometer) | | | | | | | | | |
| | | 10.8 ~ 13.5V | 13.5 ~ 17V | 17 ~ 22V | 22 ~ 27V | 27 ~ 33V | 33 ~ 40V | 38 ~ 46V | 43 ~ 53V | 49 ~ 58V | |
| | CURRENT ADJ. RANGE | Adjustable for A-Type only (via the built-in potentiometer) | | | | | | | | | |
| | | 3 ~ 5A | 2.58 ~ 4.3A | 1.95 ~ 3.25A | 1.62 ~ 2.71A | 1.3 ~ 2.17A | 1.08 ~ 1.81A | 0.93 ~ 1.55A | 0.81 ~ 1.36A | 0.72 ~ 1.21A | |
| | VOLTAGE TOLERANCE Note.3 | ±2.0% | ±2.0% | ±1.0% | ±1.0% | ±1.0% | ±1.0% | ±1.0% | ±1.0% | ±1.0% | |
| | LINE REGULATION | ±0.5% | ±0.5% | ±0.5% | ±0.5% | ±0.5% | ±0.5% | ±0.5% | ±0.5% | ±0.5% | |
| | LOAD REGULATION | ±1.5% | ±1.5% | ±0.5% | ±0.5% | ±0.5% | ±0.5% | ±0.5% | ±0.5% | ±0.5% | |
| SETUP, RISE TIME | 500ms, 80ms /230VAC 400ms, 80ms /347VAC, 480VAC | | | | | | | | | | |
| HOLD UP TIME (Typ.) | 16ms / 347VAC 30ms / 480VAC | | | | | | | | | | |
| INPUT | VOLTAGE RANGE Note.5 | 180 ~ 528VAC 254VDC ~ 747VDC (Please refer to "STATIC CHARACTERISTIC" section) | | | | | | | | | |
| | FREQUENCY RANGE | 47 ~ 63Hz | | | | | | | | | |
| | POWER FACTOR (Typ.) | PF ≥ 0.98/230VAC, PF ≥ 0.97/277VAC, PF ≥ 0.97/347VAC, PF ≥ 0.93/480VAC @full load (Please refer to "POWER FACTOR (PF) CHARACTERISTIC" section) | | | | | | | | | |
| | TOTAL HARMONIC DISTORTION | THD < 20% (@ load ≥ 60%/230VAC, 277VAC, 347VAC; @ load ≥ 75%/480VAC) (Please refer to "TOTAL HARMONIC DISTORTION (THD)" section) | | | | | | | | | |
| | EFFICIENCY (Typ.) | 86.5% | 87.5% | 88.5% | 89% | 89% | 89.5% | 89.5% | 90% | 90% | |
| | AC CURRENT (Typ.) | 0.22A / 347VAC 0.18A / 480VAC | | | | | | | | | |
| | INRUSH CURRENT (Typ.) | COLD START 25A(twidth=420µs measured at 50% I _{peak}) at 480VAC; Per NEMA 410 | | | | | | | | | |
| | MAX. No. of PSUs on 16A CIRCUIT BREAKER | 12 units (circuit breaker of type B) / 20 units (circuit breaker of type C) at 480VAC | | | | | | | | | |
| LEAKAGE CURRENT | <0.75mA / 480VAC | | | | | | | | | | |
| PROTECTION | OVER CURRENT | 95 ~ 108% Constant current limiting, recovers automatically after fault condition is removed | | | | | | | | | |
| | SHORT CIRCUIT | Constant current limiting, recovers automatically after fault condition is removed | | | | | | | | | |
| | OVER VOLTAGE | 14.4 ~ 16.8V | 18 ~ 21V | 23 ~ 27V | 28 ~ 34V | 34 ~ 38V | 41 ~ 46V | 47 ~ 53V | 54 ~ 60V | 59 ~ 65V | |
| | OVER TEMPERATURE | Shut down o/p voltage, recovers automatically after temperature goes down | | | | | | | | | |
| ENVIRONMENT | WORKING TEMP. | T _{case} =-40 ~ +80°C (Please refer to "OUTPUT LOAD vs TEMPERATURE" section) | | | | | | | | | |
| | MAX. CASE TEMP. | T _{case} =+80°C | | | | | | | | | |
| | WORKING HUMIDITY | 20 ~ 95% RH non-condensing | | | | | | | | | |
| | STORAGE TEMP., HUMIDITY | -40 ~ +80°C, 10 ~ 95% RH | | | | | | | | | |
| | TEMP. COEFFICIENT | ±0.03%/°C (0 ~ 60°C) | | | | | | | | | |
| SAFETY & EMC | VIBRATION | 10 ~ 500Hz, 5G 12min./1cycle, period for 72min. each along X, Y, Z axes | | | | | | | | | |
| | SAFETY STANDARDS | UL8750, CSA C22.2 No. 250.0-13, IP65 or IP67 approved | | | | | | | | | |
| | WITHSTAND VOLTAGE | I/P-O/P:3.75KVAC I/P-FG:2KVAC O/P-FG:1.5KVAC | | | | | | | | | |
| | ISOLATION RESISTANCE | I/P-O/P, I/P-FG, O/P-FG:100M Ohms / 500VDC / 25°C / 70% RH | | | | | | | | | |
| | EMC EMISSION | Compliance to EN55015, EN61000-3-2 Class C (@ load ≥ 60%); EN61000-3-3, FCC Part 15 Subpart B | | | | | | | | | |
| OTHERS | EMC IMMUNITY | Compliance to EN61000-4-2,3,4,5,6,8,11, EN61547, light industry level (surge immunity Line-Earth 4KV, Line-Line 2KV) | | | | | | | | | |
| | MTBF | 612.6K hrs min. Telcordia SR-332 (Bellcore); 208K hrs min. MIL-HDBK-217F (25°C) | | | | | | | | | |
| DIMENSION | DIMENSION | 189*61.5*36.8mm (L*W*H) | | | | | | | | | |
| | PACKING | 0.77Kg; 18pcs/14.9Kg/0.89CUFT | | | | | | | | | |
| NOTE | <ol style="list-style-type: none"> All parameters NOT specially mentioned are measured at 347VAC input, rated load and 25°C of ambient temperature. Ripple & noise are measured at 20MHz of bandwidth by using a 12" twisted pair-wire terminated with a 0.1µf & 47µf parallel capacitor. Tolerance : includes set up tolerance, line regulation and load regulation. Please refer to "DRIVING METHODS OF LED MODULE". Please refer to "STATIC CHARACTERISTIC" sections for details. Length of set up time is measured at first cold start. Turning ON/OFF the driver may lead to increase of the set up time. The driver is considered as a component that will be operated in combination with final equipment. Since EMC performance will be affected by the complete installation, the final equipment manufacturers must re-qualify EMC Directive on the complete installation again. This series meets the typical life expectancy of >50,000 hours of operation when T_{case}, particularly (T_c) point (or TMP, per DLC), is about 75°C or less. Please refer to the warranty statement on MEAN WELL's website at http://www.meanwell.com | | | | | | | | | | |

■ **Block Diagram**

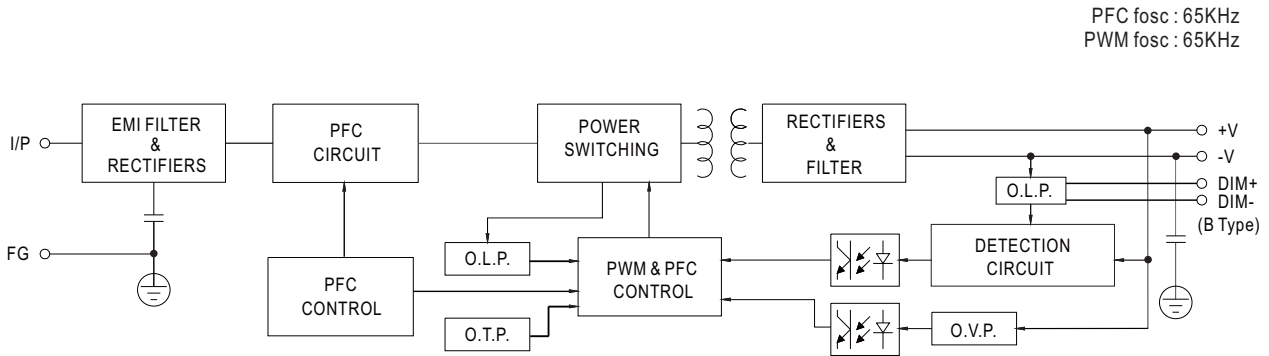

■ **DRIVING METHODS OF LED MODULE**

※ This series is able to work in either Constant Current mode (a direct drive way) or Constant Voltage mode (usually through additional DC/DC driver) to drive the LEDs.

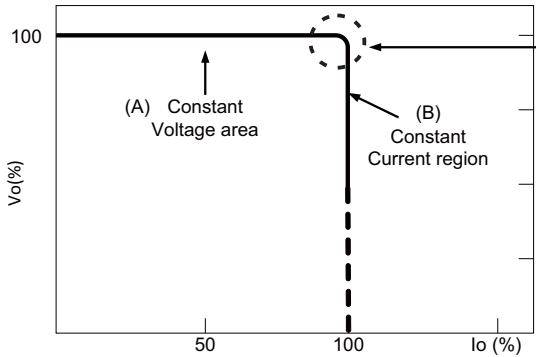

Typical output current normalized by rated current (%)

In the constant current region, the highest voltage at the output of the driver depends on the configuration of the end systems.

Should there be any compatibility issues, please contact MEAN WELL.

■ DIMMING OPERATION

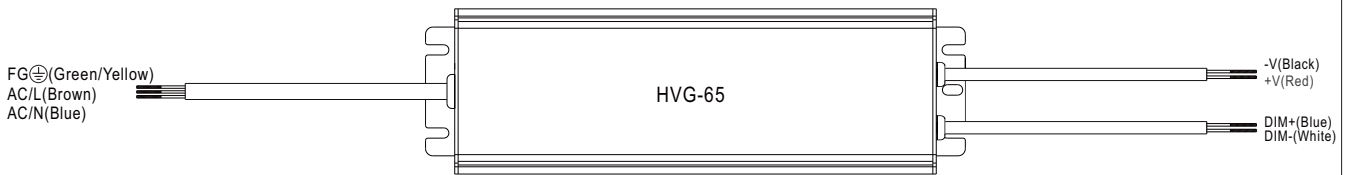

※ 3 in 1 dimming function (for B-Type)

- Output constant current level can be adjusted by applying one of the three methodologies between DIM+ and DIM-: 0 ~ 10VDC, or 10V PWM signal or resistance.
- Direct connecting to LEDs is suggested. It is not suitable to be used with additional drivers.
- Dimming source current from power supply: 100 μ A (typ.)

◎ Applying additive 0 ~ 10VDC

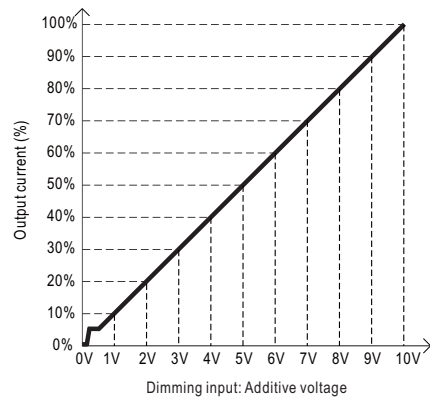
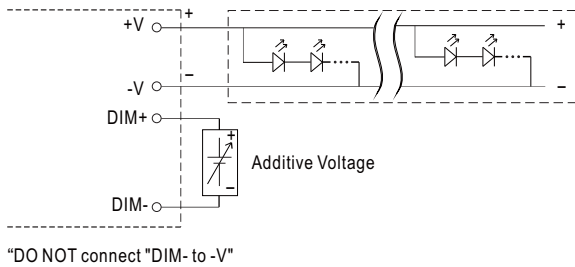

◎ Applying additive 10V PWM signal (frequency range 100Hz ~ 3KHz):

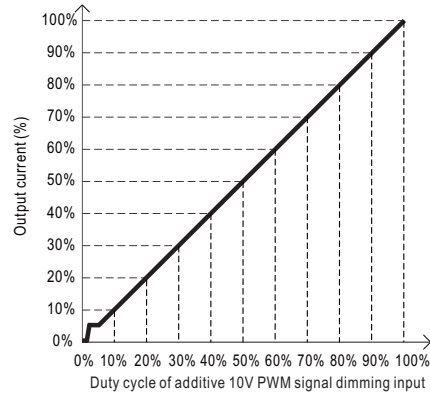
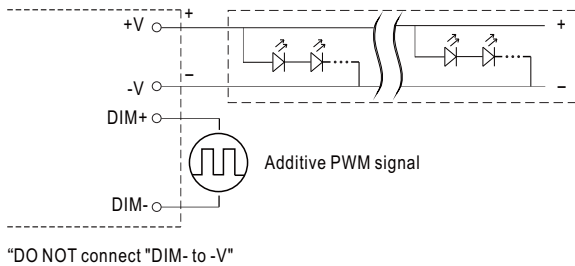

◎ Applying additive resistance:

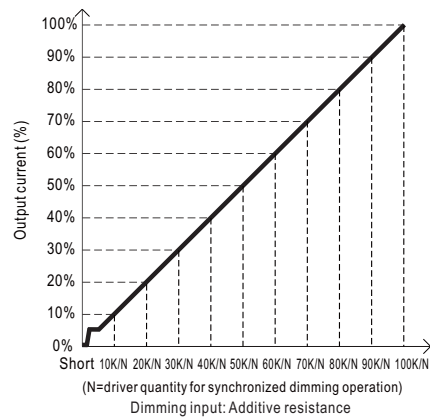
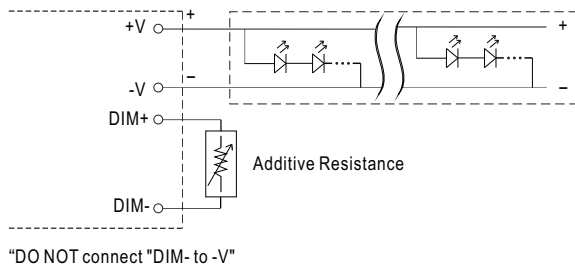

Note : 1. Min. dimming level is about 8% and the output current is not defined when $0\% < I_{out} < 8\%$.
 2. The output current could drop down to 0% when dimming input is about $0k\Omega$ or 0Vdc, or 10V PWM signal with 0% duty cycle.

OUTPUT LOAD vs TEMPERATURE

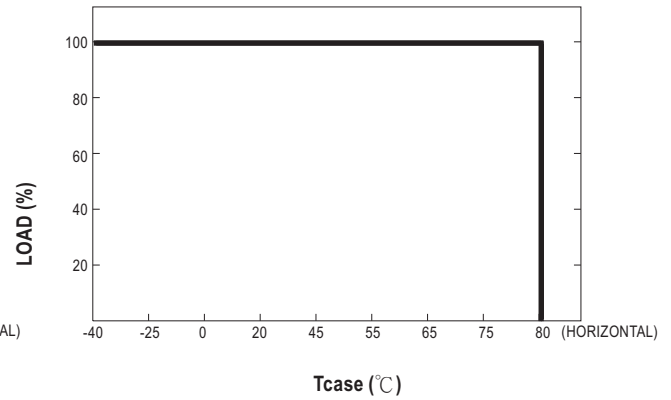
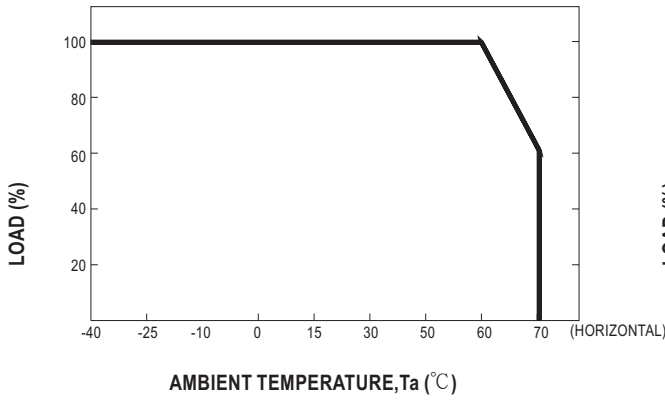

STATIC CHARACTERISTIC

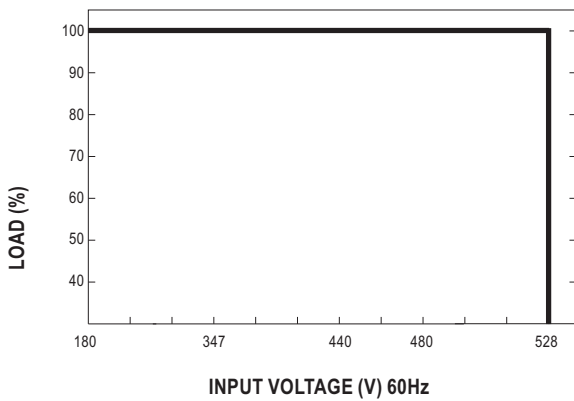

POWER FACTOR (PF) CHARACTERISTIC

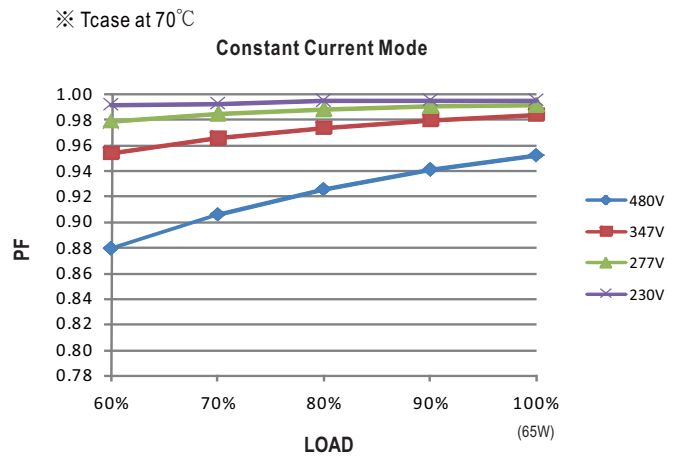

TOTAL HARMONIC DISTORTION (THD)

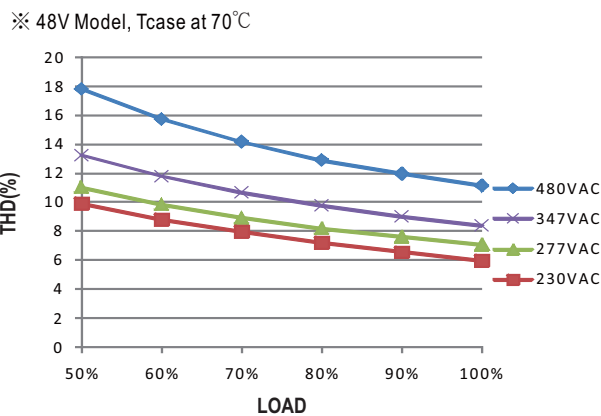

EFFICIENCY vs LOAD

HVG-65 series possess superior working efficiency that up to 90% can be reached in field applications.

※ 48V Model, Tcase at 70°C

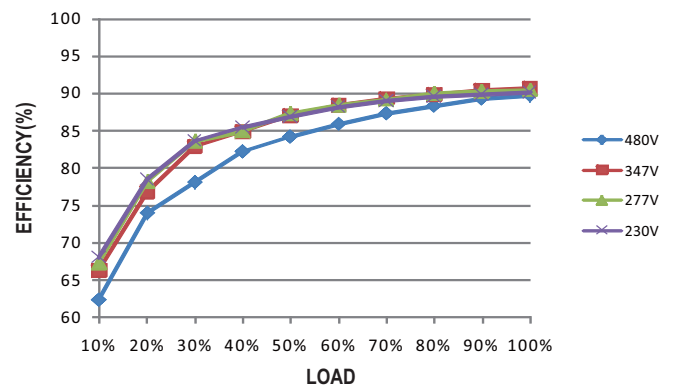

■ LIFE TIME

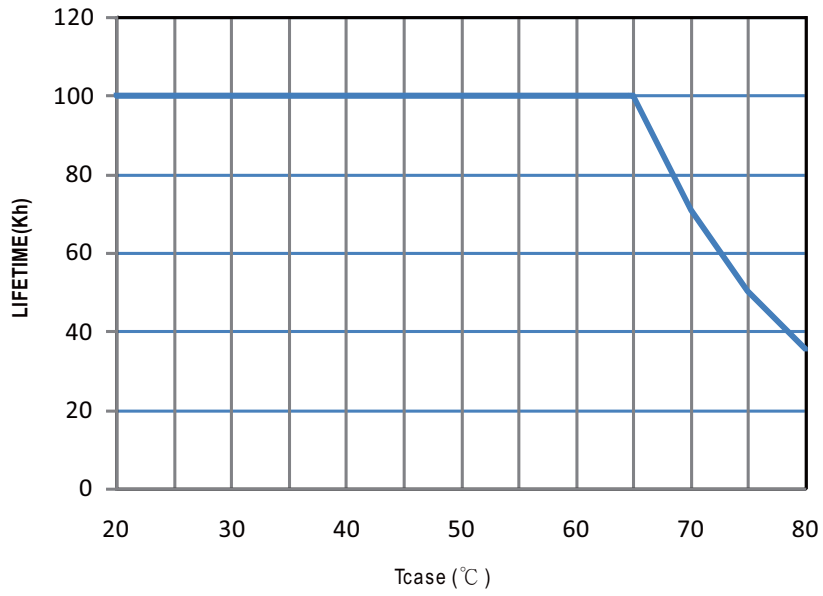

MECHANICAL SPECIFICATION

Case No. 957 Unit:mm

※ A-Type

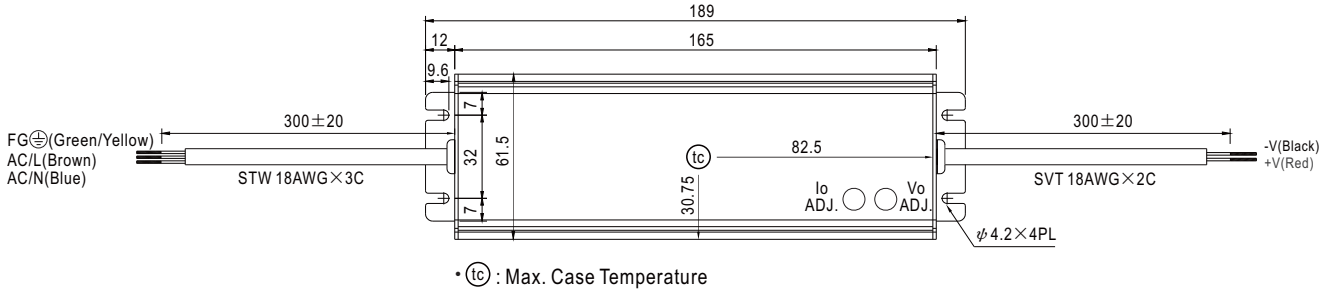

※ B-Type

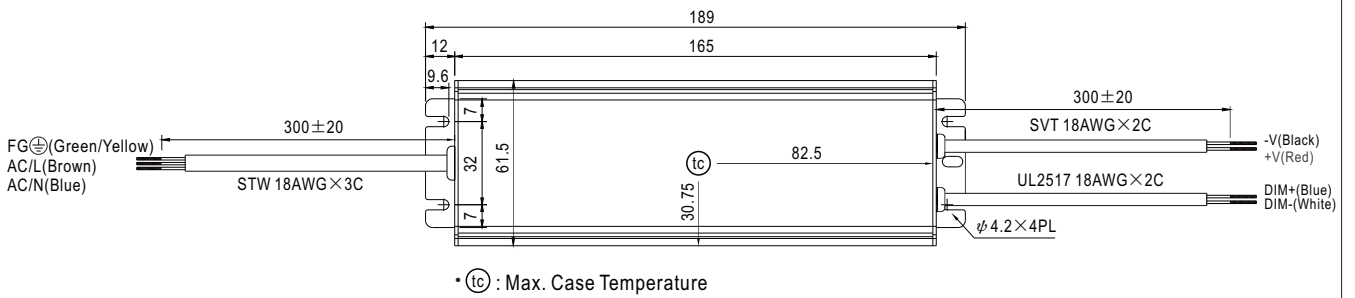

※ D-Type

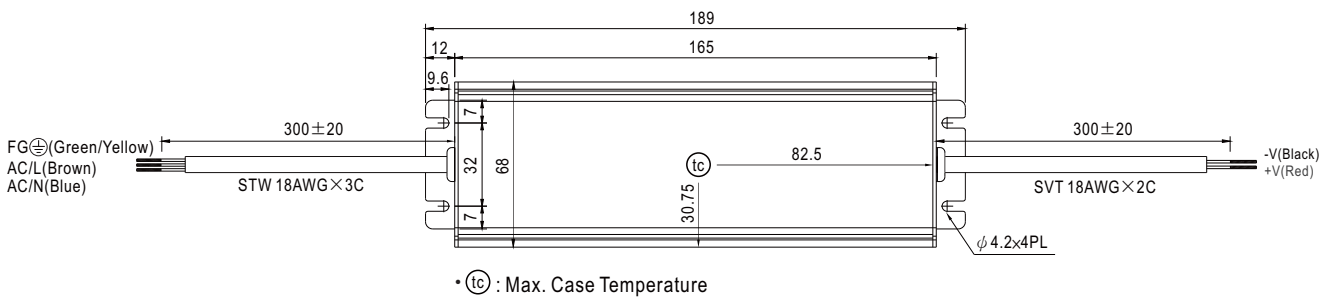

WATERPROOF CONNECTION

※ **Waterproof connector**

Waterproof connector can be assembled on the output cable of HVG-65 to operate in dry/wet/damp or outdoor environment.

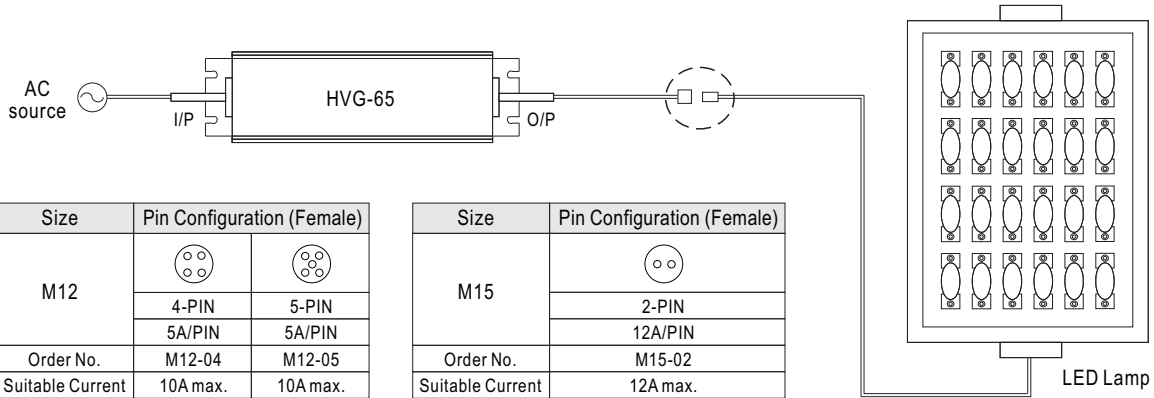

※ **Cable Joiner**

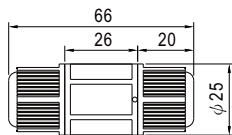

CJ04-1 suitable for 14AWG~16AWG
 CJ04-2 suitable for 18AWG~22AWG



Up to four wires can be connected through this cable joiner by soldering or clamping by tools.

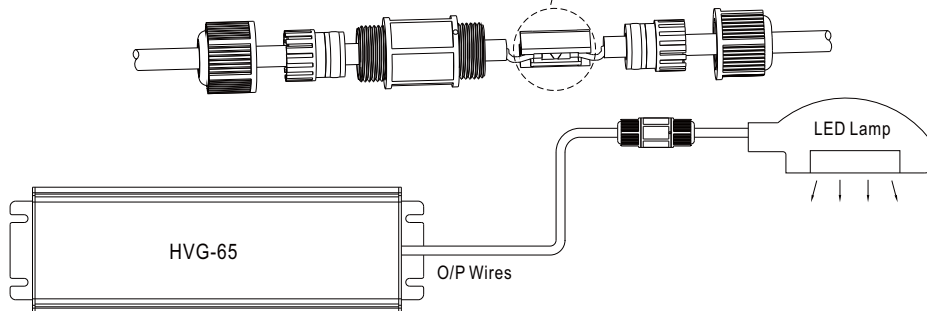

© CJ04 cable joiner can be purchased independently for user's own assembly.
 MEAN WELL order No. : CJ04-1, CJ04-2.

INSTALLATION MANUAL

Please refer to : <http://www.meanwell.com/webnet/search/InstallationSearch.html>